

Thor Able Launch Vehicle for Pioneer 1

This kit is based on Eric Truax's thor missile. Some of the internal parts and the connectors are optional to the original kit. Therefore this instruction in some respects differs from the original kit.

Print the kit on thin A4 cardboard - remember to print the dark rectangle on the backside of the modelsheet.

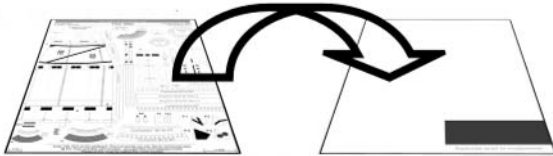

Materials Needed: Scissors - a sharp knife - an extremely sharp (preferable fresh) razor blade - craft/paper glue - Touch up colors of paint, white out, pencils-etc - a straight-edge/ruler - small diameter rod/large diameter wire - dental picks or a similar object to poke a hole into parts and pull them into position - kite type string (or similar) for reinforcement rods/engine nozzle rings - tweezers or similar.

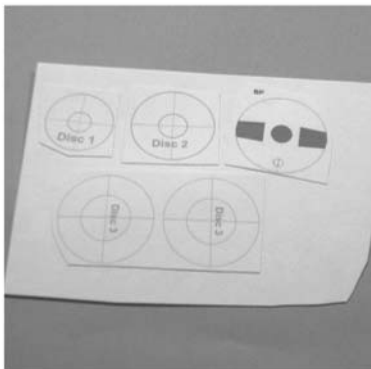

Glue the discs 1, 2, 3 and BP to white cardboard as shown. Cut out B-3. If you want to

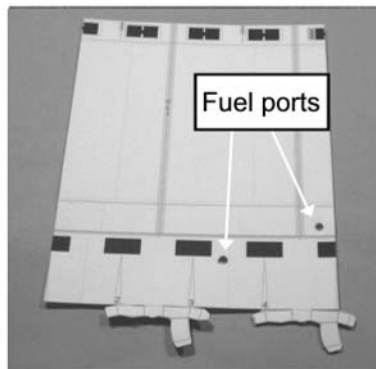

build the model with 3D fuel ports - then cut out the printed ports, for later installation of the "Optional parts FP".

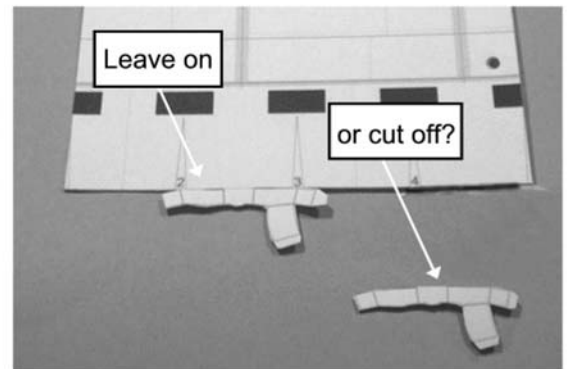

For best result keep the the gimbal motor pods attached to B3. An alternative is to cut them off and fold them separately, and re-attach them later.

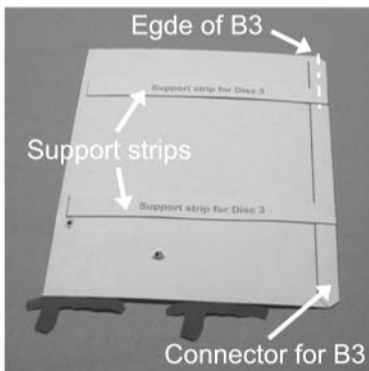

Glue the connector for B3 and the strips for disc 3 to the backside of B3. Use the red markers as guidelines.

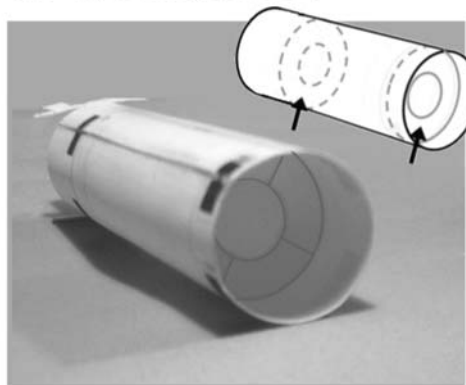

When dry roll B3 into a tube. Glue the discs 3 inside the top and the bottom of B3.

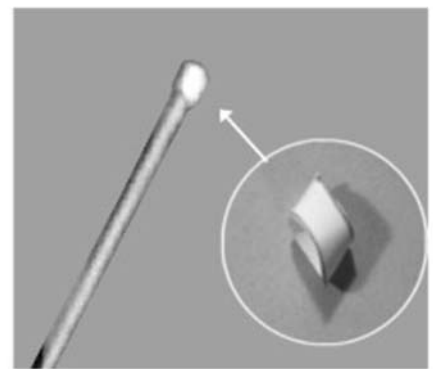

If you did cut out the fuel ports, roll "Optional parts FP" around a toothpick or a small piece of wire. Make 2.

Thor Able Launch Vehicle for Pioneer 1

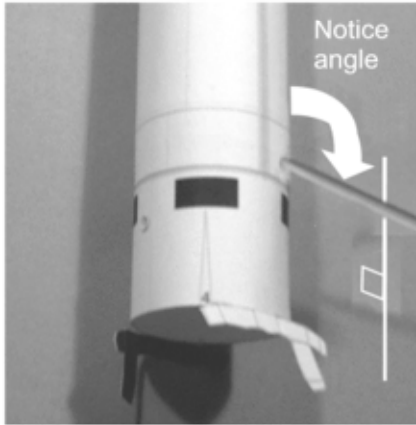

Use the toothpick to insert the completed FP into the holes in the body tube B-3. Dryfit first - then glue.

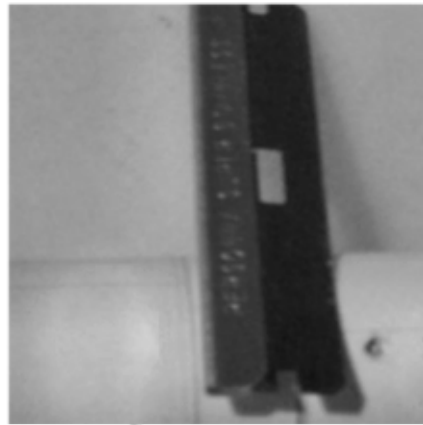

If necessary use a fresh razor blade to trim the port flush with the body wall

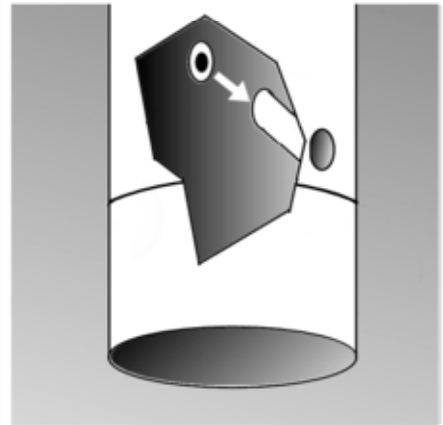

Glue the small discs to "FP" - use a pair of tweezers to place them correctly.

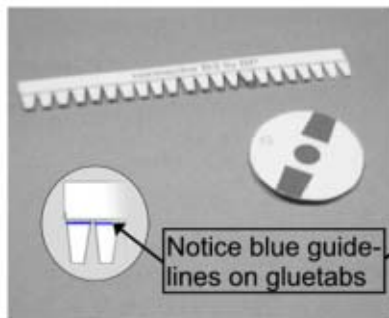

Cutout BP. Trim it, so it fits inside the rocket body B3. Cutout the connector for BP.

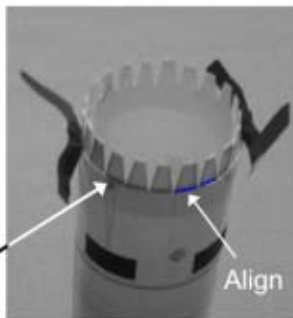

Glue the connector inside B3. Align the blue guideline with the edge of B3. In this way, the folded gluetabs are 0,5 mm below the edge.

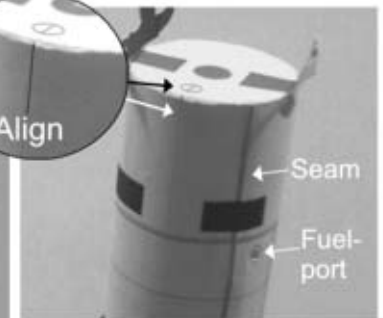
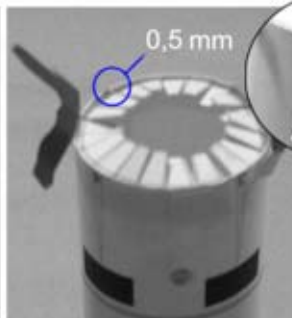

Glue BP to B3 as shown on the picture above.

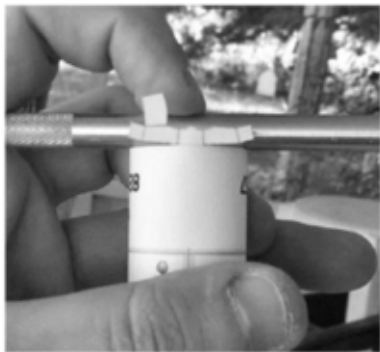

Use the the handle of a hobby knife or similar to fit BP flush with the edge of B3.

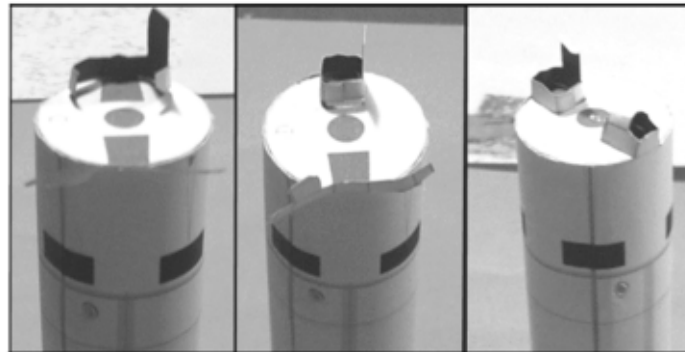

The gimbal motor pods are assembled as shown above and attached to BP. Use only a small amount of glue.



Glue the connector B3 to B2 inside the top of B3.

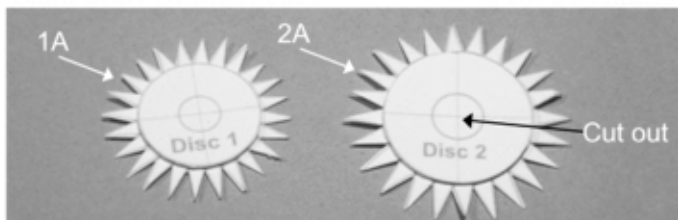

Glue disc 1 together with 1A and disc 2 with 2A. Cut out the hole in the middle.

Glue B2 and B1 into cones using the connectors.

Then glue the connectors for the next stage into the top.

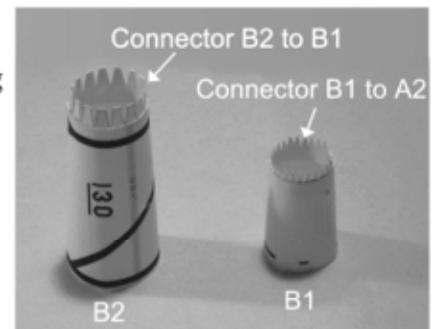

Thor Able Launch Vehicle for Pioneer 1

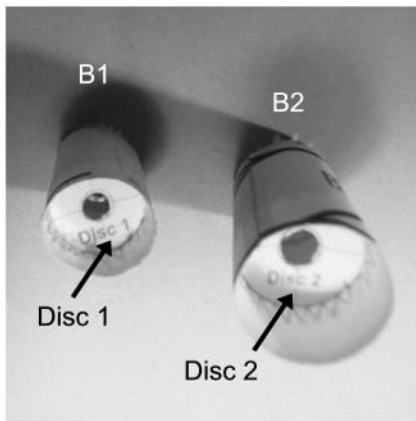

Glue disc 1 and disc 2 inside cone B1 and B2.

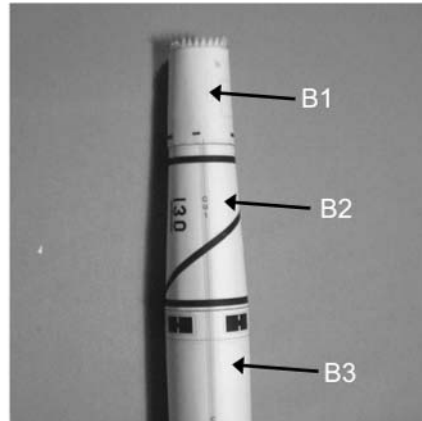

Glue B2 to B3, and then B1 to B2. Use a small rod to roll the conduit parts CL and CU into

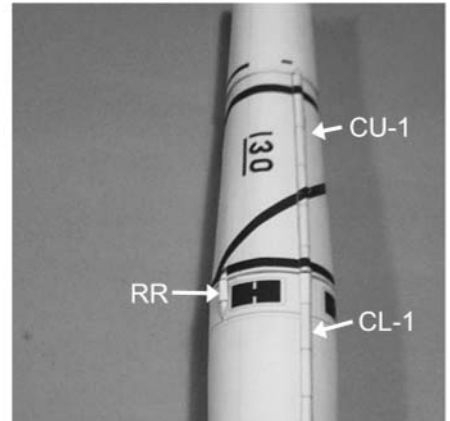

shape - and glue them in place as indicated on the rocket. Do the same with the parts RR.

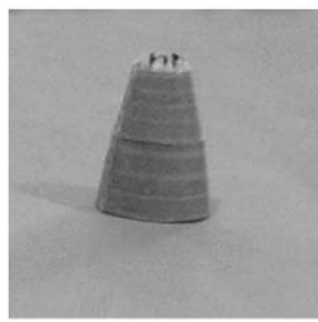
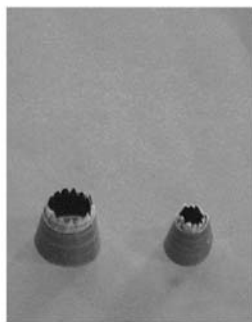
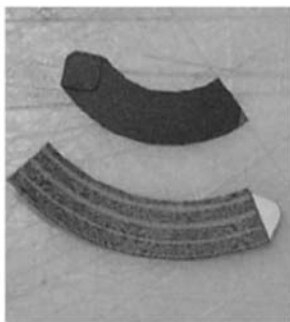

Cut out the main rocket nozzle parts R-1, and R-2, and the respective glue tabs and connectors. Glue each half together, and when dry, assemble them to form the Main Rocket Nozzle.

Unwinding and separating kite type string into 3 separate strands.



Mix a drop of black acrylic paint with a large amount of white glue to a matching grey color. Soak the string in the glue.

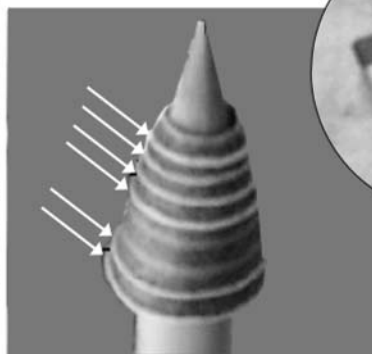

Wrap the kite string around the engine nozzle - ONLY THE 6 PLACES SHOWN.

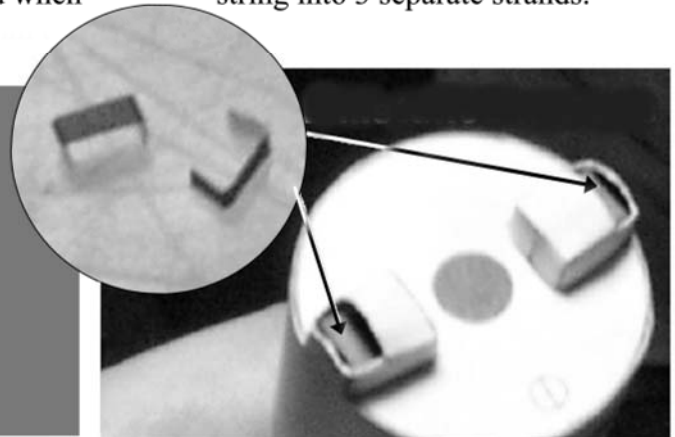

Fold parts GM-b and install them into the pods as shown above.

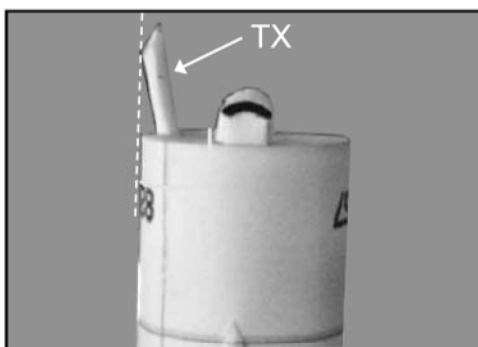

Glue TX in to a tube. Then glue TX to the small circle on the rockets base. Align it so that the seam is directly toward the center, while the vent is facing directly outward and away from the center.

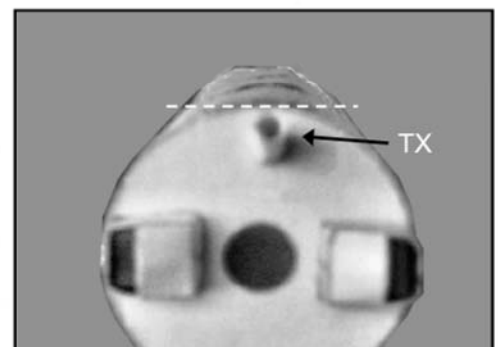

Thor Able Launch Vehicle for Pioneer 1

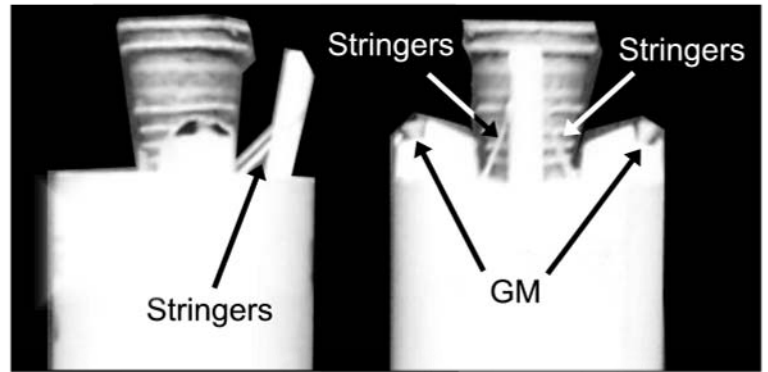
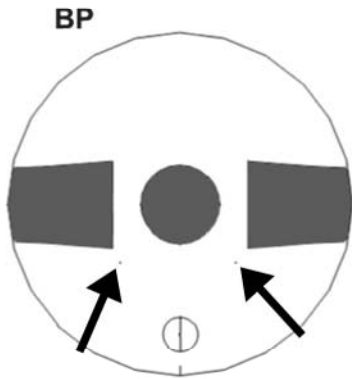

Notice the 2 dots on TX and the 2 dots on the base plate. Connect the dots with 2 pieces of thin wire or glue impregnated strands of the

kite string. Roll the Gimbal Motor nozzles (GM) into a cone using the point of a round toothpick. Glue them into the Pods, so the it is centered front to back. As these were made to swivel, any pointing left to right is OK!

Attaching the fins

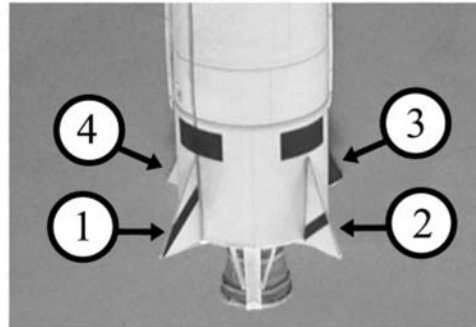
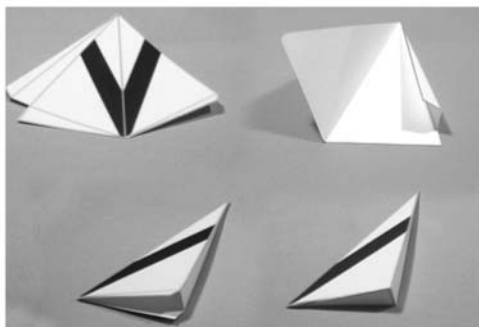

Assemble the 4 fins as shown above.

Glue the fins to the rockets body.

Assembling the upper stages

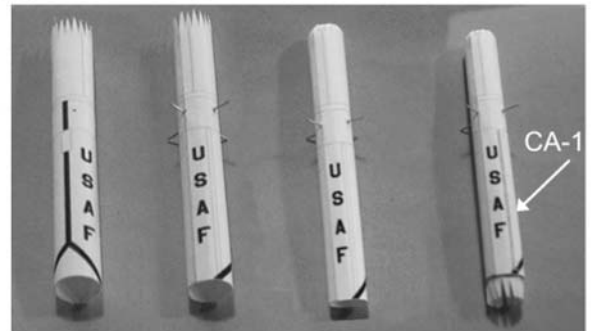
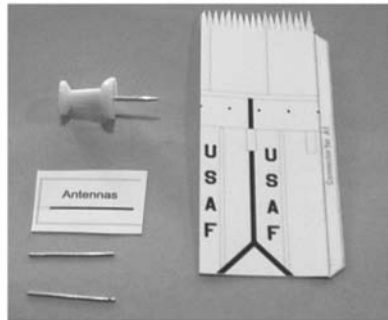
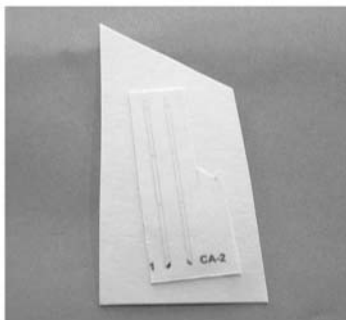

Glue CA-1 and CA-2 to a piece of white cardboard. Cut out two small pieces of wire using the antenna template. Glue the connector to part A1. Use a needle to make holes in the 5 (!) places indicated by the black dots. Make sure that the holes match the size of the antennas.

Roll A1 into a tube. Put the antenna into position. Give the tip of the stage its rounded shape. Glue CA-1 and CA-2 to A2 as shown.

Thor Able Launch Vehicle for Pioneer 1

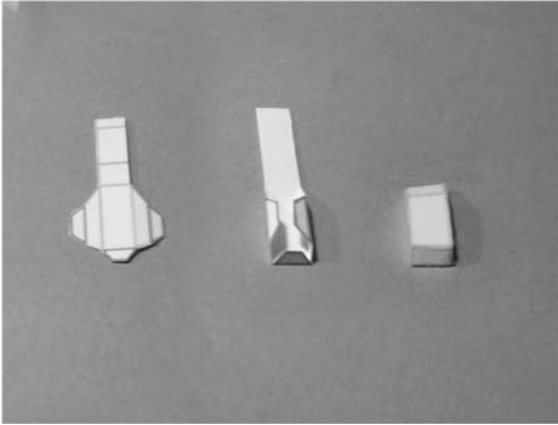

Fold the 2 boxes as shown above.

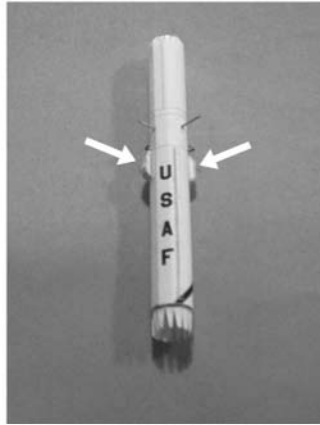

Glue them to A1.

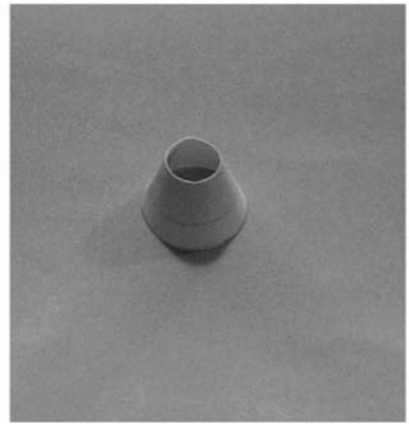

Glue A2 into a cone.



Glue A1 to A2.



Glue the upper stages to the rest of the rocket.

Assemble the rocket stand.

(Do not glue the rocket to the stand.)

Your model is finished.